

# Mobile Router MR600

## User Guide

## 1. Connections and LEDs

The following pictures show you various connectors and status LED indicators on the MR600 Mobile Router.

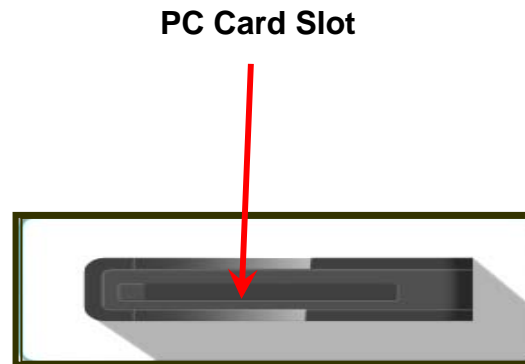
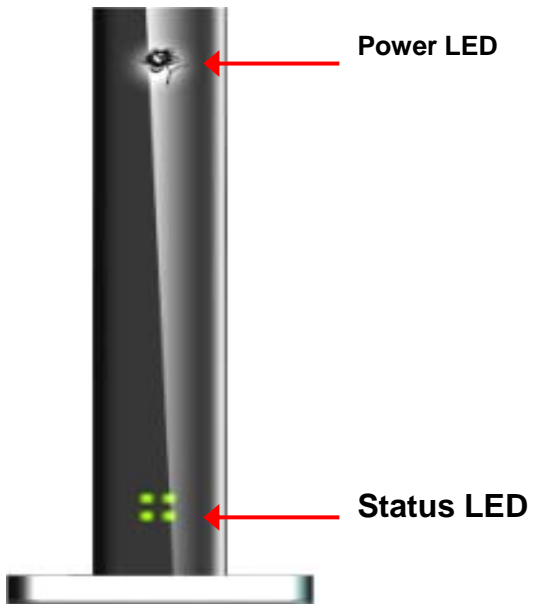

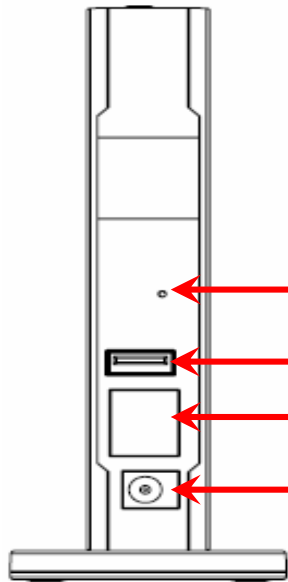

Default Button

USB Port (Optional)

Ethernet LAN Port

Power Jack



WiFi Secure  
Set Button

## 2. Getting Start

Before getting started, make sure your 32-bit PC Card or USB Data Card supports and compatible with broadband service. (Subject to services and Service terms available from your carriers).

**STEP 1 : Insert Data card to PC card slot or USB Port**

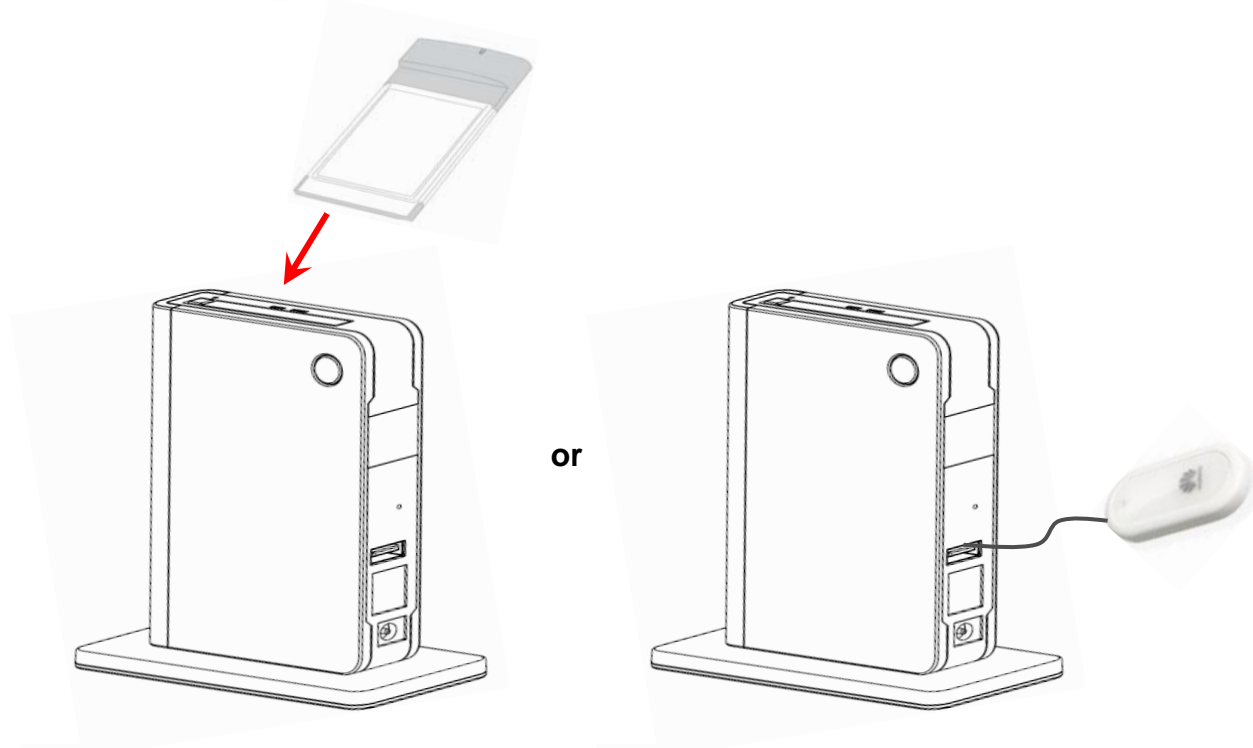

## STEP 2 : Plug in power adapter

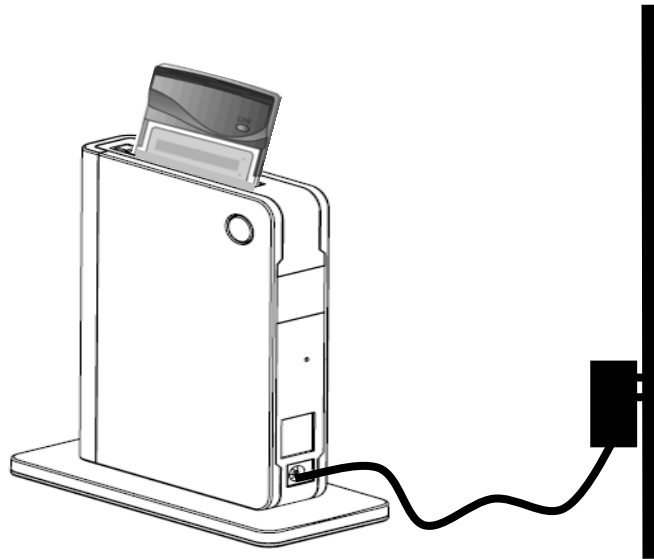

When connect the power adapter to back panel power Jack, the power LED turns ON to indicate power has been applied.

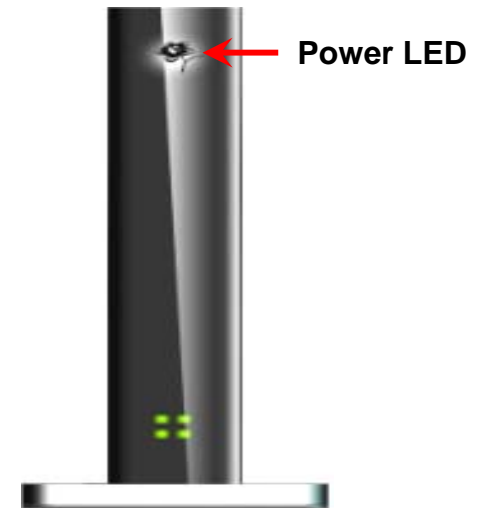

### STEP 3 : Check Status LED

When power on MR600, it will auto-detect and initial your date card. Status LED Will Flash ON and OFF One by one when MR600 performs initialization and Internet connection process. MR600 will be auto-configured properly for your Internet Service Account. This process takes a few minutes.

When complete, the status LED illuminates in Green Please refer the below Status LED Activity table for each State

LED Color	Activity	State
None	None	No Date Card Inserted or No Internet Connection
Green	Flash One by one	System initialization State
Red	Always ON	Card Error
Green	Always ON	High Speed Internet Connection
Green	Flash at Same time	Low Speed Internet Connection

### 3. Congratulation! You have Connected With Wireless Internet

MR600 is PnP for your Data card. It configures and enables wireless LAN automatically. If you have any problem or need more advanced feature setting, please refer to chapter 5 for more details.

### 4. Advance Setting through Web page

STEP 1 : Connect your PC/Notebook to MR600

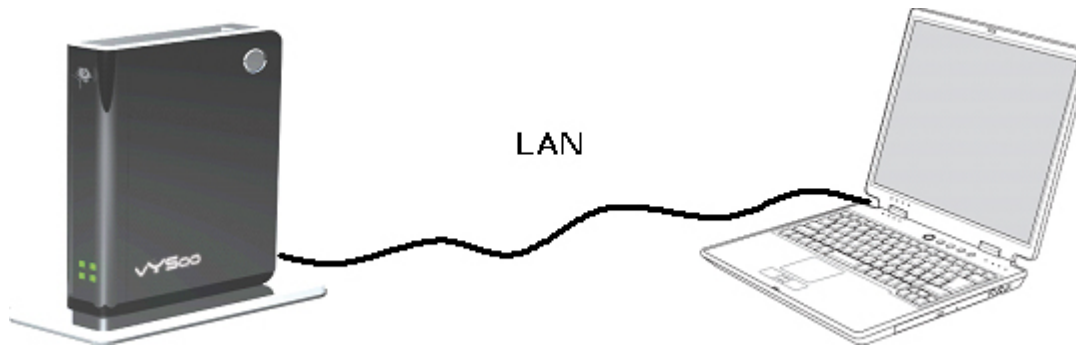

**STEP 2 :** Open your web browser such as IE or Netscape and type Press Enter <http://192.168.1.1> in address bar.

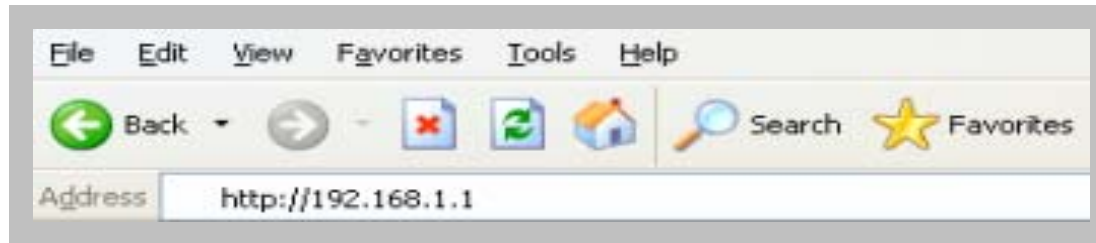

### **STEP 3 : Login Mobile Router**

- Enter your user name in the **Username** box. The default user name is **admin**..
- Enter your password in the **Password** box. The default password is **admin**.
- Click **OK**.





**STEP 4 : Once logged in the following screen is displayed**

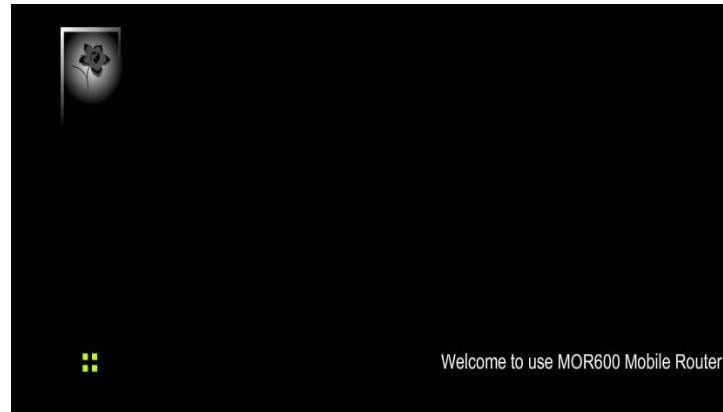

**STEP 5 : Click WWAN for WAN Networking Setting**

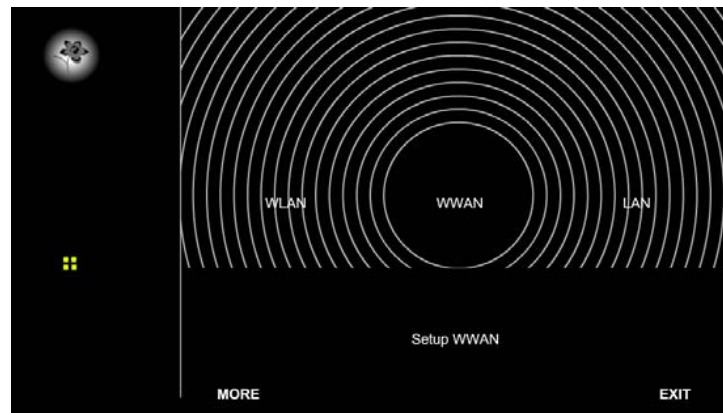

Note : The WAN fields may not be necessary for your connection. Information on this page will only be used when your service provider requires you to enter User Name and Password to connect to the broadband Network.

Please refer to your Data Card documentation or service provider for addition



<b>Dial Number</b>	The default is *99#. This field should not be altered unless required by your service provider.
<b>User Name</b>	Enter the new User Name for your Data card connection.
<b>Password</b>	Enter the new Password for your Data card connection.
<b>APN</b>	Enter the name of your service Provider Network.

## STEP 6 : Click WLAN for wireless network setting

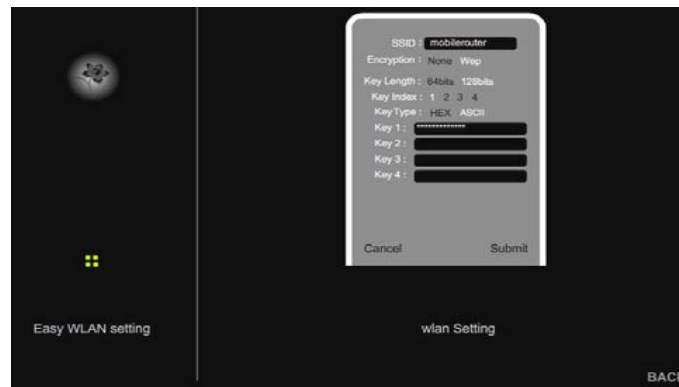

<b>SSID</b>	Enter your SSID name in the field provided. SSID names can contain up to 32 ASCLL characters.
<b>Encryption</b>	You may select from two levels of encryption to secure your wireless Network : None or WEP.
<b>Key Length</b>	Two levels of wireless encryption are available 64 bits and 128 bits
<b>Key Type</b>	Two type of WEP Key Hex or ASCII. choose the proper one for key Setting.
<b>Key1~Key4</b>	You can enter the WEP key by manually and choose Key1~Key4 for enable.

**STEP 7 : Click LAN for Local Network setting**



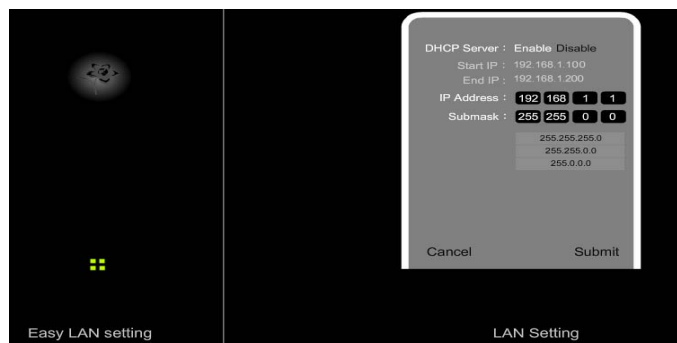

<b>DHCP Server</b>	This setting is used to configure MR600's Dynamic Host Configuration Protocol (DHCP) server function. MR600 can be used as a DHCP server for the internal LAN network. The DHCP server automatically assigns an IP address to each computer in the LAN network. If you choose to enable MR600 s DHCP server option, you must configure all of PCs in the LAN network to connect to this DHCP server (MR600), and make sure there is no other DHCP server on your network.
<b>Start IP Address</b>	Enter the values for start IP address. The default start IP address is 192.168.1.100
<b>End IP address</b>	Enter the values for end IP address. The default end IP address is 192.168.1.200
<b>IP address</b>	The IP Address of the LAN. The default IP address is 192.168.1.1
<b>Net mask</b>	The subnet mask of the LAN

Note : When DHCP server IP address range is set , it must be assured that there is no other device in the network to use the IP address located in this address range , such as printer server , file server , etc . Otherwise there is